

IGWK..D2 – Supporting-type Current Transformer

The IGWK..D2 is used for measurement and protection in applications. This model is specially designed for an extended creepage distance. The cast resin insulated indoor supporting-type current transformer can be used up to 24 kV. The current transformer is maintenance-free and mountable in any position.

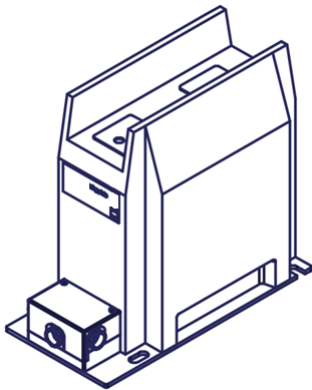

Ordering Specifications

For the customized design of your ELEQ IGWK..D2 Current Transformer the following information is required:

Mandatory

- Rated primary current
- Rated secondary current
- Rated output
- Accuracy class
- Frequency

Optional

- Primary switchover
- Other relevant requirements

Wiring diagram IEC 61869-2

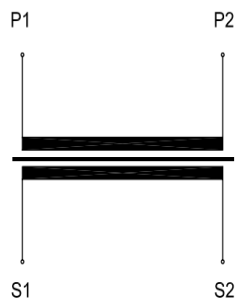

Technical specifications

Environmental conditions	
This product is designed to be safe under the following conditions:	
Location:	Indoor use
Ambient air temperature:	-5°C .. +40°C; other temperatures on request
Storage and transport temperature:	-25°C .. +50°C
Relative humidity:	5% .. 95%, non condensing
Altitude:	Max. 1000m above NN; at >1000m data required
Protection degree (secondary terminal):	IP20
Application conditions	
Standard:	IEC 61869-2/IEEE C 57.13; etc.
IEC 61768-2 specification:	
Rated short-time thermal current (I _{th}):	100 x I _n /1s, max. 50kA/1s
Rated dynamic current (I _{dyn}):	2,5 x I _{th} , max. 125kA/1s
Continuous thermal current (I _{cth}):	up to 200%
Rated insulation level:	24/50/125kV
Rated frequency:	50/60Hz
Class of insulation:	E
Rated primary current:	5A – 2500A
Rated secondary current:	1A or 5A; other options available on request
Rated output:	As required. For example 2,5VA, 10VA, 30VA
Accuracy class:	As required. For example 0,2S, 5P10
Primary connection:	M12 (40Nm)
Secondary terminal:	Screw terminals M5 (max. 2,5Nm)

Dimensions

