

IGHDF 12 – Bushing-type Current Transformer

The IGHDF 12 - bushing-type current transformer is capable to withstanding the outdoor environmental condition. The cast resin insulated outdoor current transformer can be used up to 12 kV, is maintenance-free and mountable only in an upright position. The secondary windings are used for measurement and/or protection purposes.

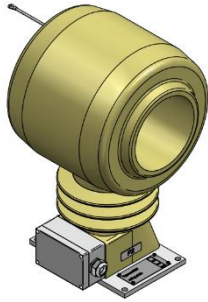

Ordering Specifications

For the customized design of your ELEQ IGHDF 12 current transformer the following information is required:

Mandatory

- Rated primary current
- Rated secondary current
- Rated output
- Accuracy class
- Frequency

Optional

- Multi-core transformers
- Secondary switch-over
- Other relevant requirements

Dimensions

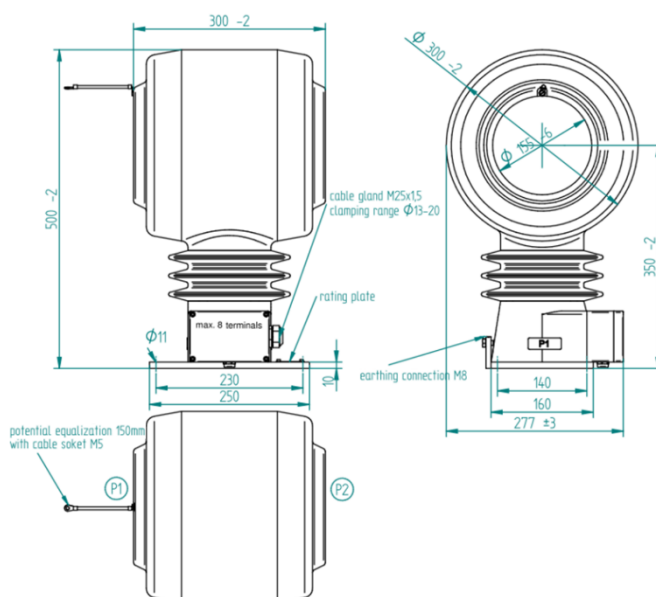

Technical specifications

Environmental conditions	
This product is designed to be safe under the following conditions:	
Location:	Outdoor use
Ambient air temperature:	-40°C .. +50°C; other temperatures on request
Storage and transport temperature:	-50°C .. +80°C
Relative humidity:	5% .. 95%, non condensing
Altitude:	Max. 1000m above NN; at >1000m data required
Protection degree (secondary terminal):	IP55
Application conditions	
Standard:	IEC 61869-2 / IEEE C57.13, etc.
IEC 61768-2 specification	
Rated short-time thermal current (I _{th}):	100 x I _n /1s, max. 100kA/1s, other duration on request
Rated dynamic current (I _{dyn}):	2,5 x I _{th}
Continuous thermal current (I _{cth}):	Up to 200% at 2500A
Rated insulation level:	12/28/75kV
Rated frequency:	50/60Hz
Class of insulation:	E
Rated primary current:	10-5000A
Rated secondary current:	1A or 5A; other options available on request
Rated output:	As required. For example 15VA
Accuracy class:	As required. For example 0,2; 0,5; 5P20
Secondary terminal:	Max. 8 terminals; cable gland M25x1,5

Wiring diagram IEC 61869-2

