

GST170 – Split Core Type Current Transformer

The GST 170 are cast-resin insulated current transformers for indoor applications. They are suitable to put on cables or bus-bars. The cast resin insulated indoor split core type current transformer can be used up to 1,2 kV, is maintenance-free and mountable according to the operation instruction.

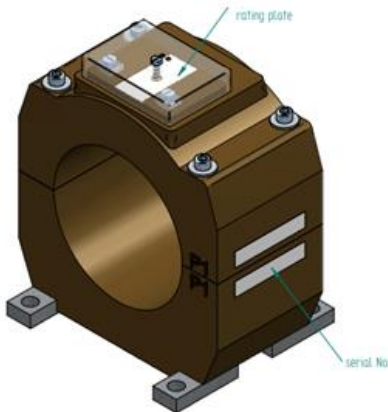

Ordering Specifications

For the customized design of your ELEQ GST170 Current Transformer the following information is required:

Mandatory

- Rated primary current
- Rated secondary current
- Rated output
- Accuracy class
- Frequency

Optional

- Other relevant requirements

Wiring diagram IEC 61869-2

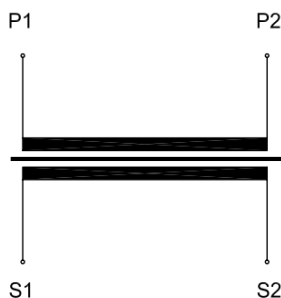

Technical specifications

Environmental conditions

This product is designed to be safe under the following conditions:

Location:	Indoor use
Ambient air temperature:	-5°C .. +40°C, other temperatures on request
Storage and transport temperature:	-25°C .. -50°C
Relative humidity:	5% .. 95%, non condensing
Altitude:	Max. 1000m above NN; at >1000m data required
Protection degree (secondary terminal):	IP20

Application conditions

Standard:	IEC 61869-2 / IEEE C57.13; etc.
IEC 61768-2 specification:	
Rated short-time thermal current (I _{th}):	100 x I _n /1s, max. 100kA/1s, other duration on request
Rated dynamic current (I _{dyn}):	2,5 x I _{th}
Continuous thermal current (I _{cth}):	Up to 200%
Rated insulation level:	0,72/3/- kV or 1,2/6/-kV
Rated frequency:	50/60Hz
Class of insulation:	E
Rated primary current:	20-2000A
Rated secondary current:	1A or 5A; other options available on request
Rated output:	As required. For example 10VA, 15VA
Accuracy class:	As required. For example 0,5, 5P20
Secondary terminal:	Screw terminals M5 (max. 2,5Nm)

Dimensions

