

# GSA110 – Bushing-type Current Transformer

The GSA110 is a cast-resin insulated bushing-type current transformer for indoor applications. They are suitable to put on cables or bus-bars. In case of higher voltage levels the primary conductor must be insulated according to the rated insulation levels. The cast resin insulated indoor bushing-type current transformer can be used up to 1,2 kV. The current transformer is maintenance-free and mountable in any position.

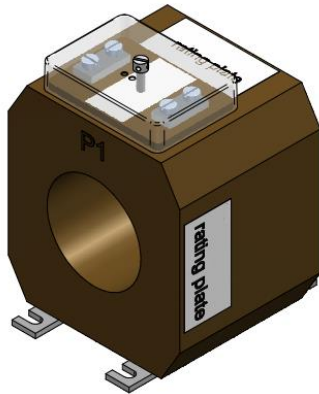

## Ordering Specifications

For the customized design of your ELEQ GSA110 Current Transformer the following information is required:

### Mandatory

- Rated primary current
- Rated secondary current
- Rated output
- Accuracy class
- Frequency

### Optional

- Multi-core transformers are possible
- Terminal box sealable
- Other relevant requirements

## Wiring diagram IEC 61869-2 e.g. single core

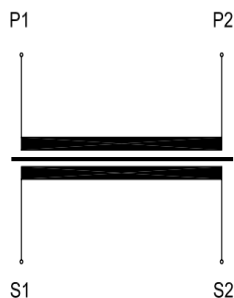

## Technical specifications

<b>Environmental conditions</b>	
This product is designed to be safe under the following conditions:	
Location:	Indoor use
Ambient air temperature:	-5°C .. +40°C; other temperatures on request
Storage and transport temperature:	-25°C .. +50°C
Relative humidity:	5% .. 95%, non condensing
Altitude:	Max. 1000m above NN; at >1000m data required
Protection degree (secondary terminal):	IP20
<b>Application conditions</b>	
Standard:	IEC 61869-2/IEEE C 57.13; etc.
IEC 61768-2 specification:	
Rated short-time thermal current (I <sub>th</sub> ):	100 x I <sub>n</sub> /1s, max. 100kA/1s, other duration on request
Rated dynamic current (I <sub>dyn</sub> ):	2,5 x I <sub>th</sub>
Continuous thermal current (I <sub>cth</sub> ):	up to 200%
Rated insulation level:	1,2/6/-kV
Rated frequency:	50/60Hz
Class of insulation:	E
Rated primary current:	30A - 1000A
Rated secondary current:	1A or 5A; other options available on request
Rated output:	As required. For example 10VA, 15VA
Accuracy class:	As required. For example 0,2, 5P20
Secondary terminal:	Screw terminals M5 (max. 2,5Nm)

## Dimensions

