

# GSRF 720 – Ring-type Current Transformer

The GSRF 720 are cast-resin insulated ring-type current transformers and can be used for measurement and protection in outdoor applications. They are suitable to put on cables or bus-bars. The outdoor ring-type current transformer can be used up to 0,72 kV, is maintenance-free and mountable in any position. In medium voltage and high voltage switchgear, an insulated conductor must be used which suits the rated insulation levels.

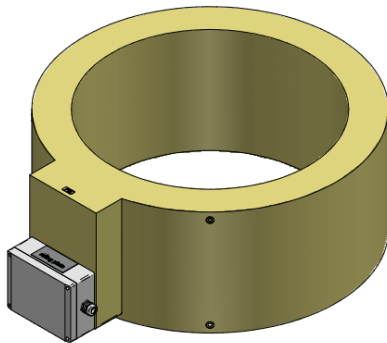

## Ordering Specifications

For the customized design of your ELEQ GSRF 720 Current Transformer the following information is required:

### Mandatory

- Rated primary current
- Rated secondary current
- Rated output
- Accuracy class
- Frequency

### Optional

- Multi-core transformers
- Other relevant requirements

## Technical Specifications

<b>Environmental conditions</b>	
This product is designed to be safe under the following conditions:	
Location:	Outdoor use
Ambient air temperature:	-25°C .. +40°C; other temperatures on request
Storage and transport temperature:	-50°C .. +55°C
Relative humidity:	5% .. 95%, non condensing
Altitude:	Max. 1000m above NN; at >1000m data required
Protection degree (secondary terminal):	IP54
<b>Application conditions</b>	
Standard:	IEC 61869-2 / IEEE C57.13; etc.
IEC 61768-2 specification:	
Rated short-time thermal current (I <sub>th</sub> ):	100 x I <sub>n</sub> /1s, max. 100kA/1s, other duration on request
Rated dynamic current (I <sub>dyn</sub> ):	2,5 x I <sub>th</sub>
Continuous thermal current (I <sub>cth</sub> ):	Up to 200%
Rated insulation level:	0,72/3/- kV
Rated frequency:	50/60Hz
Class of insulation:	E
Rated primary current:	100A - 15000A
Rated secondary current:	1A or 5A; other options available on request
Rated output:	As required. For example 10VA, 15VA
Accuracy class:	As required. For example 0,2S, 5P20
Inner diameter:	On request
Secondary terminal:	Screw terminals M5 (max. 2,5Nm)

## Wiring diagram IEC 61869-2 for e.g.

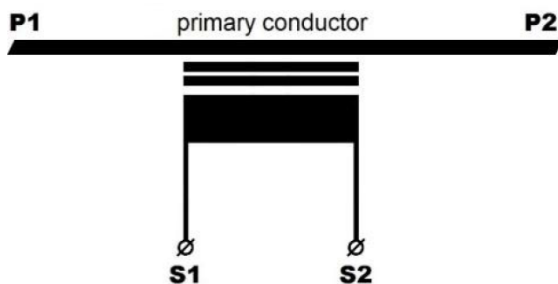

## Dimensions

