

GSRF 630 – Ring-type Current Transformer

The GSRF 630 are cast-resin insulated ring-type current transformers and can be used for measurement and protection in outdoor applications. They are suitable to put on cables or bus-bars. The outdoor ring-type current transformer can be used up to 0,72 kV, is maintenance-free and mountable in any position. In medium voltage and high voltage switchgear, an insulated conductor must be used which suits the rated insulation levels.

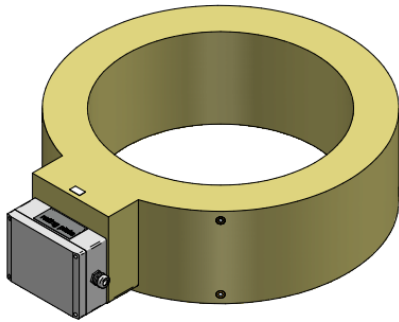

Ordering Specifications

For the customized design of your ELEQ GSRF 630 Current Transformer the following information is required:

Mandatory

- Rated primary current
- Rated secondary current
- Rated output
- Accuracy class
- Frequency

Optional

- Multi-core transformers
- Other relevant requirements

Technical Specifications

Environmental conditions	
This product is designed to be safe under the following conditions:	
Location:	Outdoor use
Ambient air temperature:	-25°C .. +40°C; other temperatures on request
Storage and transport temperature:	-50°C .. +55°C
Relative humidity:	5% .. 95%, non condensing
Altitude:	Max. 1000m above NN; at >1000m data required
Protection degree (secondary terminal):	IP54
Application conditions	
Standard:	IEC 61869-2 / IEEE C57.13; etc.
IEC 61768-2 specification:	
Rated short-time thermal current (I _{th}):	100 x I _n /1s, max. 100kA/1s, other duration on request
Rated dynamic current (I _{dyn}):	2,5 x I _{th}
Continuous thermal current (I _{cth}):	Up to 200%
Rated insulation level:	0,72/3/- kV
Rated frequency:	50/60Hz
Class of insulation:	E
Rated primary current:	100A - 15000A
Rated secondary current:	1A or 5A; other options available on request
Rated output:	As required. For example 10VA, 15VA
Accuracy class:	As required. For example 0,2S, 5P20
Inner diameter:	On request
Secondary terminal:	Screw terminals M5 (max. 2,5Nm)

Wiring diagram IEC 61869-2 for e.g.

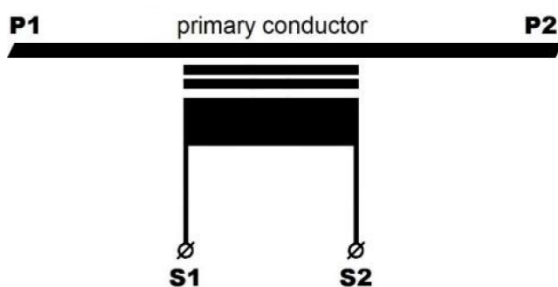

Dimensions

